

**GREENMAX™ COMPACTOR ZEUS C200**

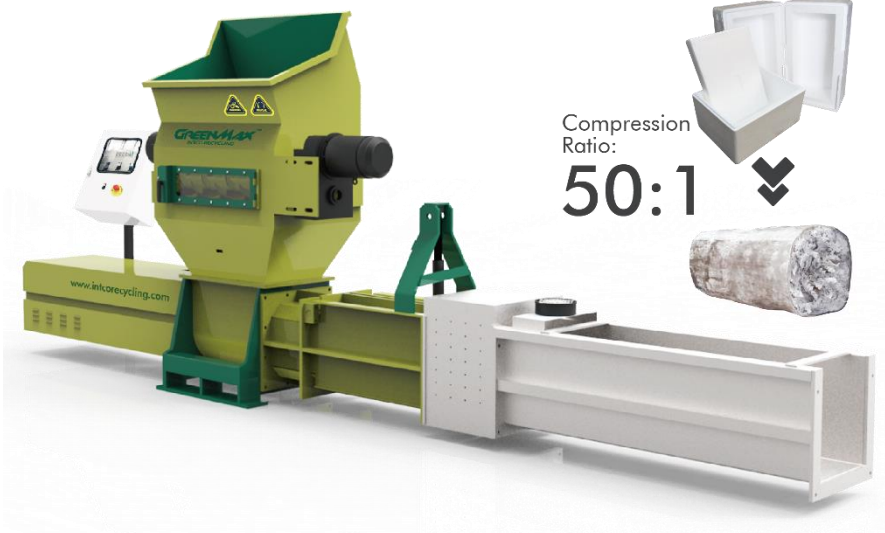

Compression Ratio:  
**50:1**

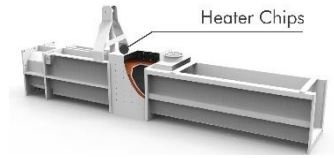

> Surface melting technology melt the surface of compacted PE foam, the inside would not expand again.

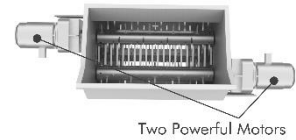

> SIEMENS control system guarantees easy and simple operation.







> Reputable & High quality components make the machine reliable and durable.



> CE approved and comply with UL/CSA standards

> Heavy crusher driven by two powerful motors is able to break PE foam, into 20-50 mm size small pieces.

**> APPLICABLE MATERIAL:**

| POLYSTYRENE   |   | POLYPROPYLENE   | POLYETHYLENE  |
|---|---|---|---|
| EPS   | EPS CUPS / TRAYS  | XPS   | EPP   |
|  |  |  |   |
|   |   |   |  |

**> DIMENSIONS**

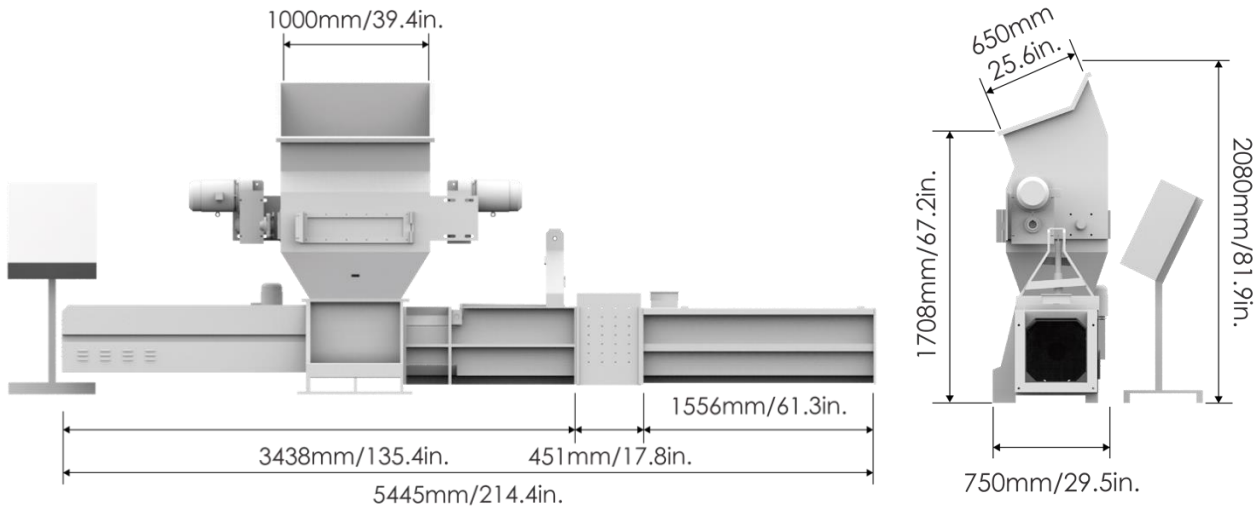

**> TECHNICAL DATA**

| ITEM                      | Z-C200  |
|---------------------------|---|
| Total Power Consumption   | 35.65 kw / 48.5 hp  |
| Crusher Power Consumption | 2*4 kw / 2*5.36 hp  |
| Production Capacity       | 200 kg per hour / 440 lbs per hour  |
| EPS Compression Ratio     | 50:1  |
| Compressed EPS Density    | 200-400 kg/m <sup>3</sup> / 570-1140 lbs/cubic yard   |
| EPS Block Dimensions      | 380*380 (w/h) mm / 15.0*15.0 (w/h) in.  |
| Feed Hopper Door          | 1000*650 (l/w) mm / 39.4*25.6 (l/w) in.   |
| Dimensions                | 5445*750*2080(l/w/h) mm / 214.4*29.5*81.9 (l/w/h) in.   |
| Shipping Dimensions       | Main part: 3950*950*2350 (l/w/h) mm / 155.5*37.4*92.5 (l/w/h) in.<br>Output chute: 1650*620*720 (l/w/h) mm / 65.0*24.4*28.3 (l/w/h) in. |
| Weight                    | 2,000 kg / 4,400 lbs  |